

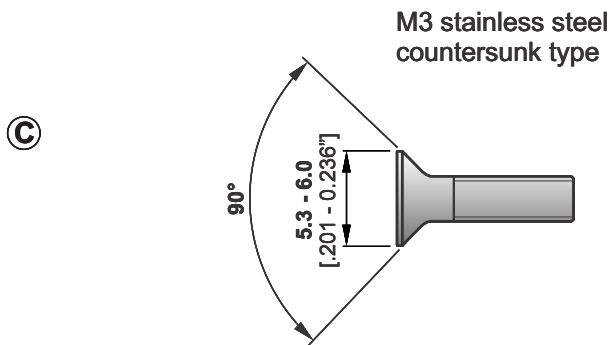

ASSEMBLY INSTRUCTION

RRE8F-Z-011 | Air tightness Data Chassis Connector

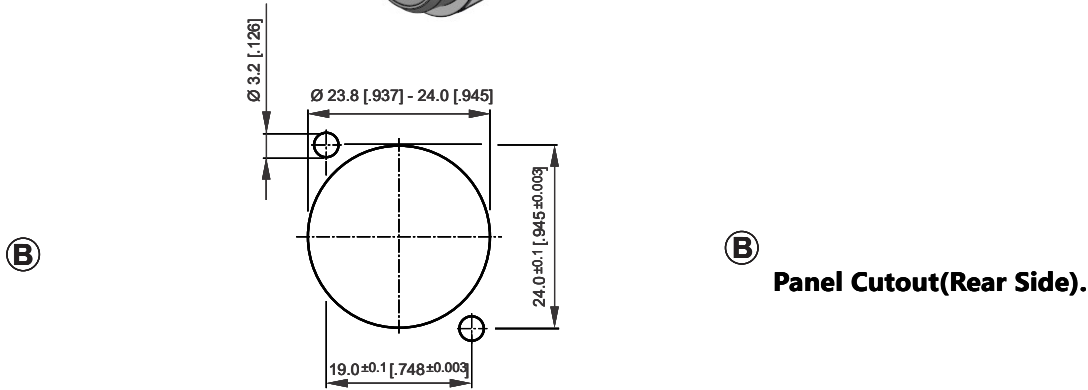
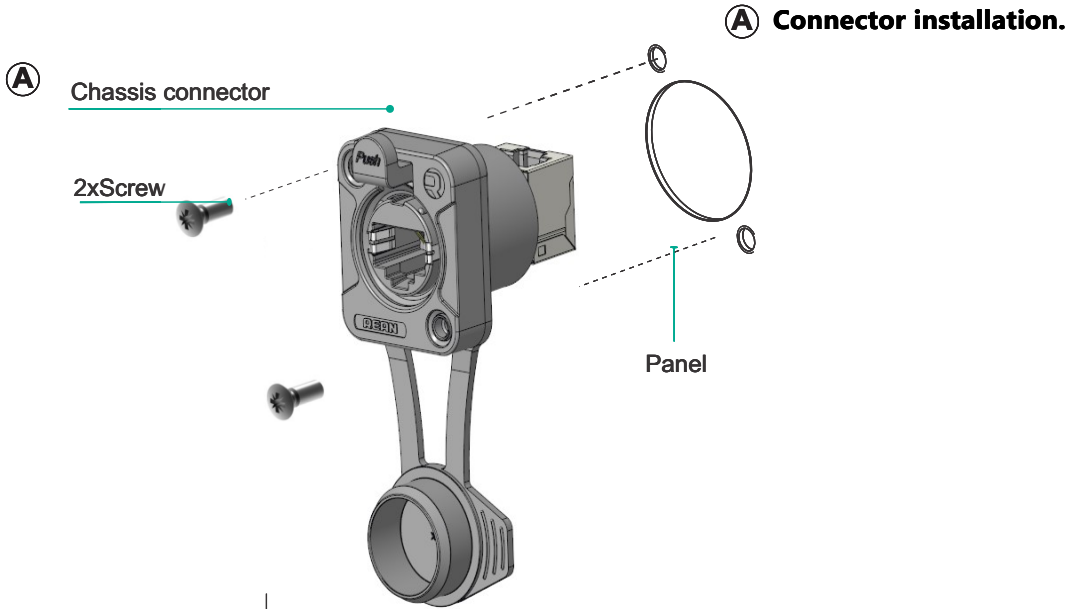

IP65 Data Chassis Connector:
Find more details on
www.rean-connectors.com



Neutrik AG	LI	T: +423 / 237 24 24	F: +423 / 232 53 93	Neutrik France	FR	T: +33 1 / 4131 6750	F: +33 1 / 4131 0511
Neutrik USA Inc.	USA	T: +1 704 / 972 3050	F: +1 704 / 438 9202	Neutrik Tokyo Ltd.	JP	T: +81 3 / 3663 4733	F: +81 3 / 3663 4796
Neutrik (UK) Ltd.	UK	T: +44 1983 / 811 441	F: +44 1983 / 811 439	Neutrik Hong Kong Ltd.	HK	T: +852 / 2687 6055	F: +852 / 2687 6052
Neutrik Vertriebs GmbH	DE/NL/AT/DK	T: +49 8131 / 280 890	F: +49 8131 / 280 830	Neutrik Trading Ltd.	CN	T: +0574 / 8825 0833	F: +0574 / 8826 5000

Draft. Nr.: NCN 015 | Update: 2021-04-06 | Data subject to change without prior notice. © 2021 REAN®. REAN® is registered trademark of Neutrik AG. ALL RIGHTS RESERVED.